

CITY OF MELFORT

BYLAW NO. 2016-03

A BYLAW OF THE CITY OF MELFORT RESPECTING THE CONSTRUCTION OF CERTAIN WORKS AS LOCAL IMPROVEMENTS, THE ESTABLISHMENT OF UNIFORM RATES AND SPECIAL ASSESSMENTS THERETO

WHEREAS the Council of the City of Melfort deems it expedient to fix a certain rate per meter frontage, which shall be a uniform rate to be specially assessed upon the land abutting directly upon the work where the work is the construction of any of the various works, pursuant to *The Local Improvements Act*, being Chapter L-33, R.S.S., 1978:

NOW THEREFORE THE COUNCIL OF THE CITY OF MELFORT IN OPEN MEETING ASSEMBLED ENACTS AS FOLLOWS:

- In making special assessments under *The Local Improvements Act* to defray the owner's portion of the cost, the uniform rates amortized at seven percent (7%) per annum shall be as follows:

	Uniform Amortized Rates - Lineal Frontage		Prepayment Rates - Lineal Frontage	
	Per Metre	Per Foot	Per Metre	Per Foot
Arterial – Rural Full Depth Pavement	\$ 91.11	\$ 27.77	\$ 491.00	\$ 149.66
Full Depth Pavement	\$ 91.11	\$ 27.77	\$ 491.00	\$ 149.66
Recap/Repair Pavement	\$ 69.58	\$ 21.21	\$ 375.00	\$ 114.30
Rolled Curb & Gutter (.51 wide)	\$ 28.76	\$ 8.77	\$ 155.00	\$ 47.24
Rolled Curb, Gutter & Sidewalk (1.71 wide)	\$ 36.18	\$ 11.03	\$ 195.00	\$ 59.44
Barrier Curb	\$ 31.54	\$ 9.61	\$ 170.00	\$ 51.82
Sidewalk (1.2 wide, with existing curb & gutter)	\$ 31.54	\$ 9.61	\$ 170.00	\$ 51.82
Sidewalk (continuous, with proposed curb & gutter)	\$ 15.77	\$ 4.81	\$ 85.00	\$ 25.91
Lane Construction (6.00 & 6.1 m)	\$ 15.40	\$ 4.69	\$ 83.00	\$ 25.30

- The uniform amortized rates set out with respect to payment shall be specially assessed upon the lands abutting directly upon the work in each of the years of the repayment period of the debt incurred of seven (7) years, which period is within the estimated ten (10) year lifetime of the work.
- That the averaging formula, or formulas, identified as Schedule "A" attached hereto and forming part of this Bylaw, be applied to irregular shaped lots to determine equalized assessable frontage.

4. Flankages abutting the work shall have the first 45.72 m or 150 ft. exempted from special assessment.
5. Tax exempt properties shall pay 100% of the flankage assessment.
6. If the special assessment for any work affected by this Bylaw exceeds the total costs of the work, the proceeds of the special rate to the amount of the excess shall be placed in a general local improvement fund and shall be used to meet the whole or a part of the City's portion of the cost of a work of a similar character or for such other capital purposes as may be approved The Saskatchewan Municipal Board.
7. This Bylaw shall not be repealed or amended except as provided in Subsection (5) of Section 20 of ***The Local Improvements Act***.
8. This Bylaw becomes effective on date of final passing.
9. Bylaw No. 2015-01 is hereby repealed.

INTRODUCED AND READ a first time this 8th day of February, 2016.

READ A SECOND TIME this 8th day of February, 2016.

READ A THIRD TIME AND PASSED this 8th day of February, 2016.

MAYOR

CITY CLERK

S E A L

CERTIFIED a true copy of Bylaw No. 2016-03 adopted by resolution of Council on the 9th day of February, 2016.

City Clerk

Schedule "A" To Bylaw 2016-03 Local Improvements Averaging Formula

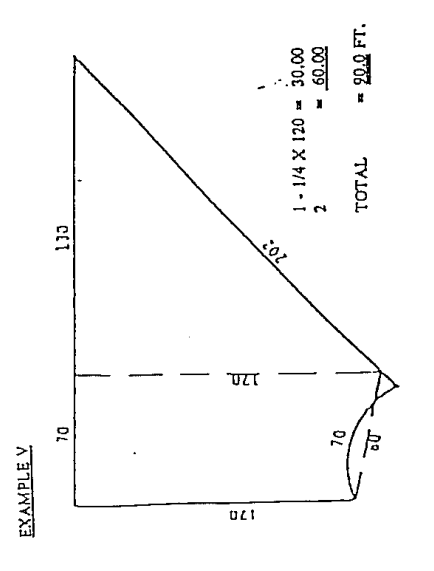
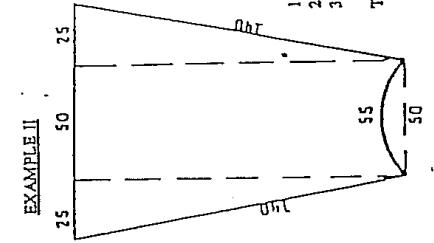
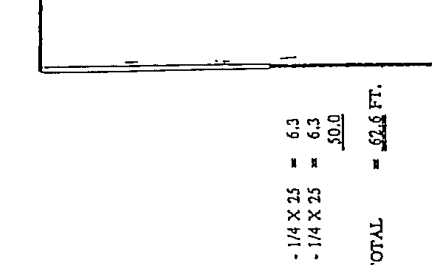
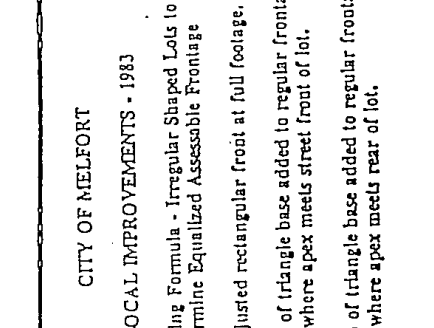
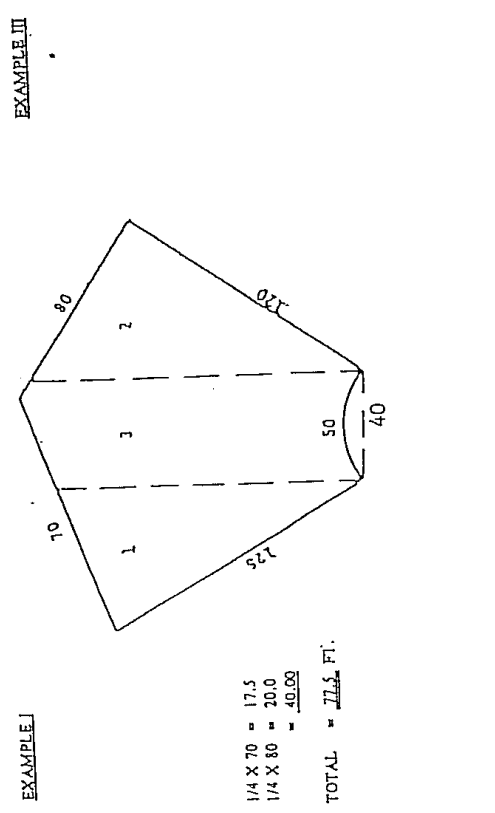
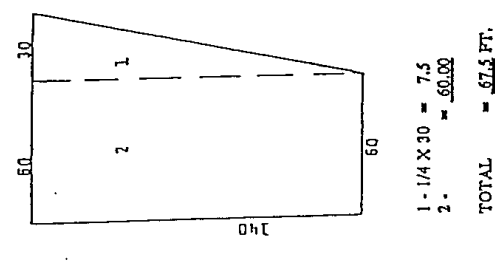
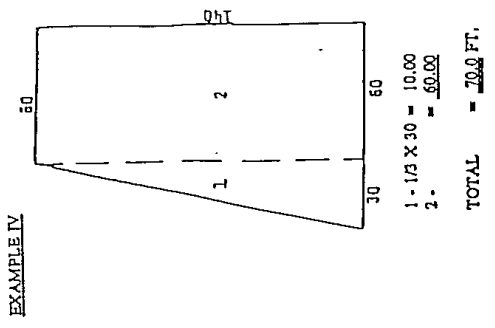

CITY OF MELFORD

LOCAL IMPROVEMENTS - 1983

Averaging Formula - Irregular Shaped Lots to
Determine Equalized Assessable Frontage

A. Adjusted rectangular front at full footage.

B. 1/4 of triangle base added to regular frontage
where apex meets street front of lot.

C. 1/3 of triangle base added to regular frontage
where apex meets rear of lot.